

N10

- PL** Instrukcja montażu
- D** Montageanleitung
- GB** Assembly instructions
- ES** Instrucciones de instalación
- FR** Instructions de montage
- CZ** Montážní návod
- UA** Інструкція монтажу
- HU** Összeszerelési útmutat
- SK** Montážny návod
- RU** Инструкция по монтажу
- IT** Istruzioni di montaggio
- RO** Instructiuni de asamblare
- TR** Montaj talimatı
- NL** Handleiding voor de montage

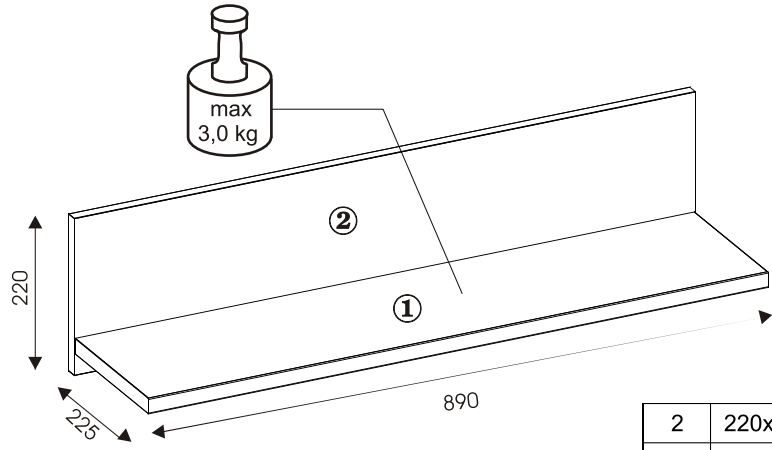

2	220x886
1	884x210

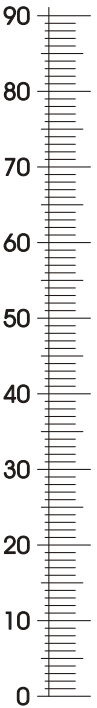
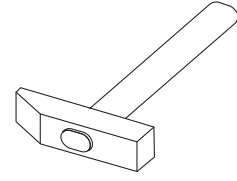
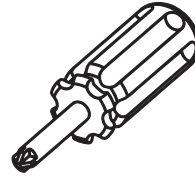
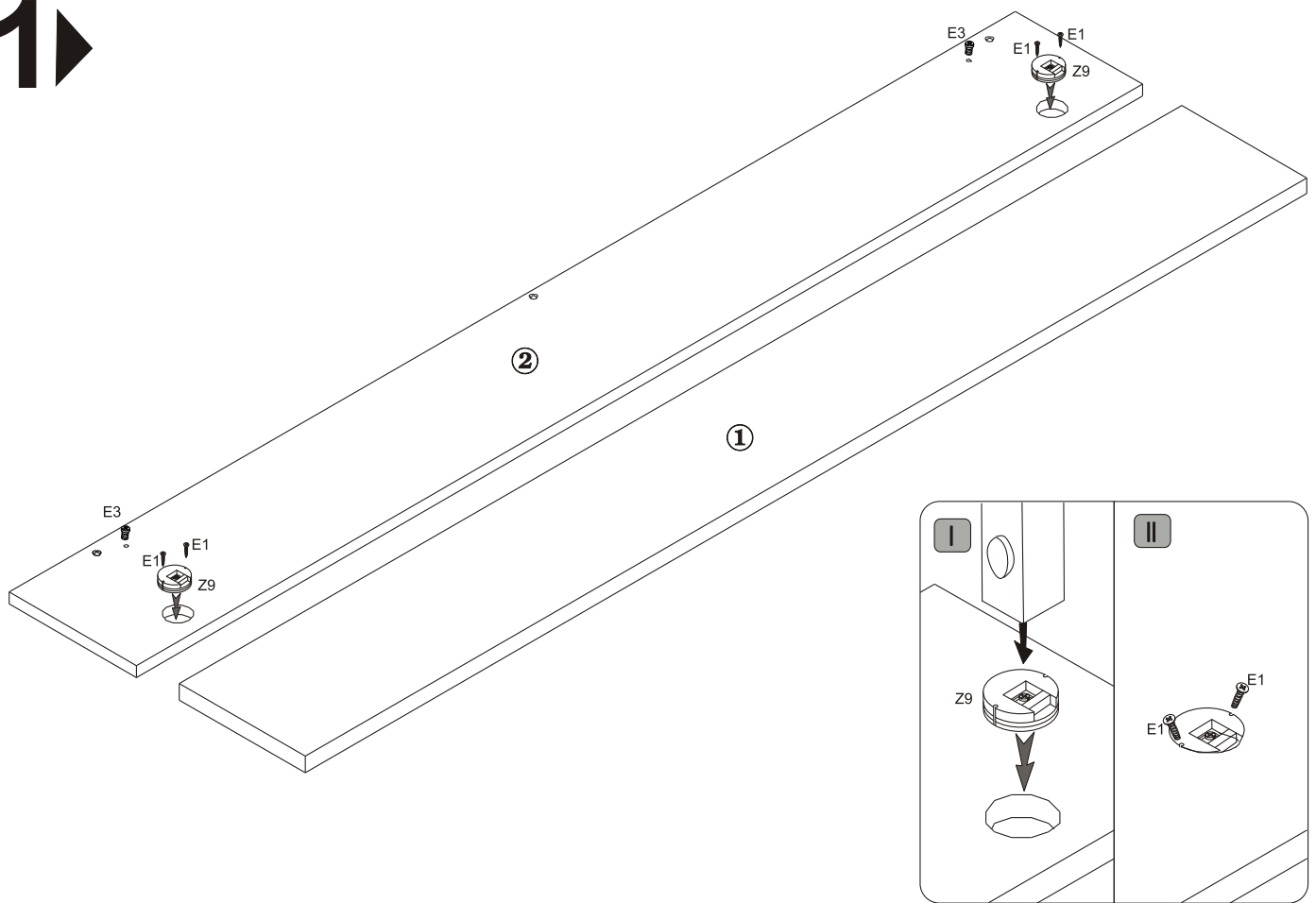

 5x60 2x W26	 10x50 2x D1	 5x11 4x E1	 6,4x50 3x K5	 6,3x13 2x E3	 2x Z9	 1x K20
-----------------------	-----------------------	----------------------	------------------------	------------------------	--------------	---------------

2

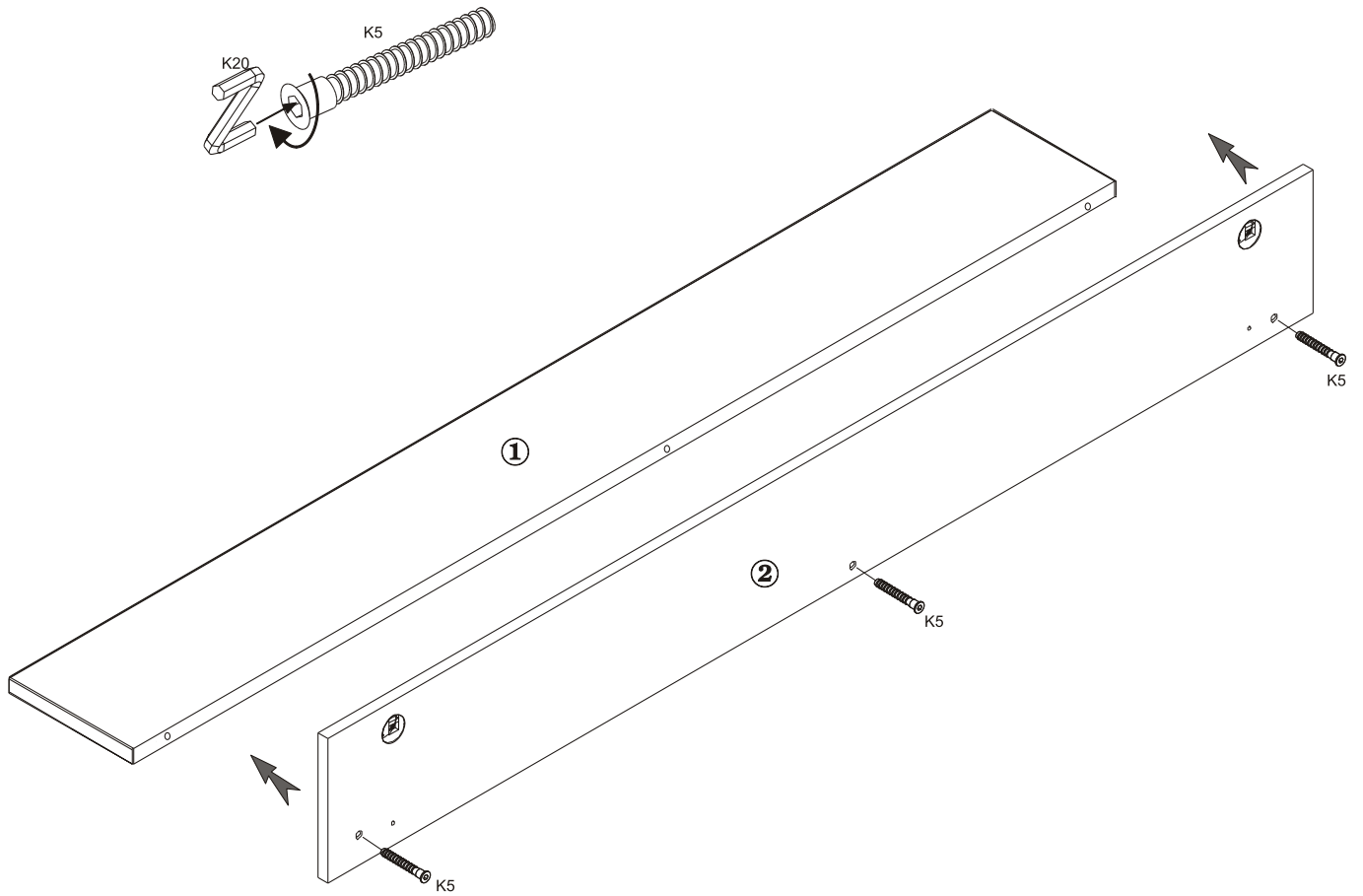

3

